

HIGH VOLTAGE NPN POWER TRANSISTOR

- REVERSE PINS OUT Vs STANDARD IPAK (TO-251) / DPAK (TO-252) PACKAGES
- HIGH VOLTAGE CAPABILITY
- HIGH DC CURRENT GAIN
- THROUGH-HOLE IPAK (TO-251) POWER PACKAGE IN TUBE (SUFFIX "-1")
- SURFACE-MOUNTING DPAK (TO-252) POWER PACKAGE IN TAPE & REEL (SUFFIX "T4")
- MINIMUM LOT-TO-LOT SPREAD FOR RELIABLE OPERATION

APPLICATIONS:

- SWITCH MODE POWER SUPPLIES

DESCRIPTION

The STD616A is manufactured using High Voltage Multi Epitaxial Planar technology for high switching speeds and high voltage withstand capability.

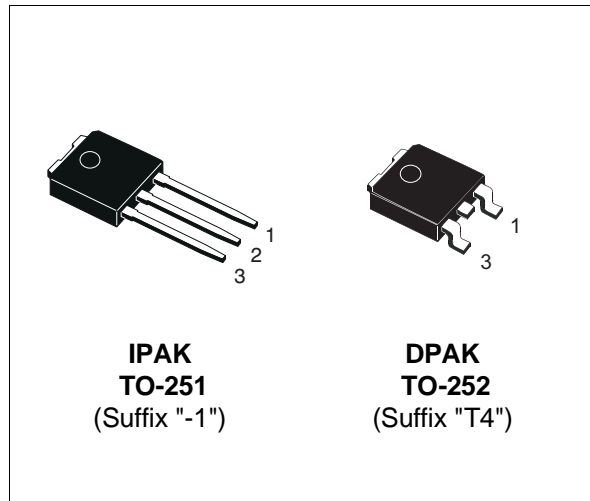
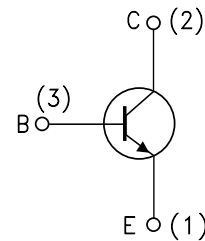
INTERNAL SCHEMATIC DIAGRAM

SC10555

ABSOLUTE MAXIMUM RATINGS

Symbol	Parameter	Value	Unit
V_{CES}	Collector-Emitter Voltage ($V_{BE} = 0$)	1000	V
V_{CEO}	Collector-Emitter Voltage ($I_B = 0$)	450	V
V_{EBO}	Emitter-Base Voltage ($I_C = 0$)	12	V
I_C	Collector Current	1.6	A
I_{CM}	Collector Peak Current ($t_p < 5$ ms)	2.4	A
I_B	Base Current	0.8	A
I_{BM}	Base Peak Current ($t_p < 5$ ms)	1.2	A
P_{tot}	Total Dissipation at $T_c = 25$ °C	20	W
T_{stg}	Storage Temperature	-65 to 150	°C
T_j	Max. Operating Junction Temperature	150	°C

STD616A

THERMAL DATA

R _{thj-case}	Thermal Resistance Junction-case	Max	6.25	°C/W
-----------------------	----------------------------------	-----	------	------

ELECTRICAL CHARACTERISTICS (T_{case} = 25 °C unless otherwise specified)

Symbol	Parameter	Test Conditions	Min.	Typ.	Max.	Unit
I _{CES}	Collector Cut-off Current (V _{BE} = 0 V)	V _{CE} = 1000 V V _{CE} = 1000 V T _j = 125 °C			50 0.5	μA mA
V _{CEO(sus)*}	Collector-Emitter Sustaining Voltage (I _B = 0)	I _C = 100 mA L = 25 mH	450			V
V _{EBO}	Emitter-Base Voltage (I _C = 0)	I _E = 1 mA	12			V
V _{CE(sat)*}	Collector-Emitter Saturation Voltage	I _C = 250 mA I _B = 65 mA I _C = 0.8 A I _B = 250 mA			0.3 0.5	V V
V _{BE(sat)*}	Base-Emitter Saturation Voltage	I _C = 250 mA I _B = 65 mA I _C = 0.8 A I _B = 250 mA			1 1.2	V V
h _{FE*}	DC Current Gain	I _C = 200 μA V _{CE} = 5 V I _C = 300 mA V _{CE} = 5 V I _C = 480 mA V _{CE} = 5 V I _C = 1.6 A V _{CE} = 5 V	17 25 12 4			
t _{on} t _s t _f	RESISTIVE LOAD Turn On Time Storage Time Fall Time	V _{CC} = 250 V I _C = 250 mA I _{B1} = 65 mA I _{B2} = -130 mA			0.2 5 0.65	μs μs μs
t _{on} t _s t _f	RESISTIVE LOAD Turn On Time Storage Time Fall Time	V _{CC} = 250 V I _C = 0.8 A I _{B1} = 160 mA I _{B2} = -0.4 A			1 2.5 0.35	μs μs μs
t _s t _f	INDUCTIVE LOAD Storage Time Fall Time	V _{cl} = 300 V I _C = 250 mA I _{B1} = 65 mA I _{B2} = -130 mA L = 200 μH			5 0.5	μs μs
t _s t _f	INDUCTIVE LOAD Storage Time Fall Time	V _{cl} = 300 V I _C = 0.8 A I _{B1} = 160 mA I _{B2} = -0.4 A L = 200 μH			2.5 0.25	μs μs

* Pulsed: Pulse duration = 300 μs, duty cycle 1.5 %

Safe Operating Area

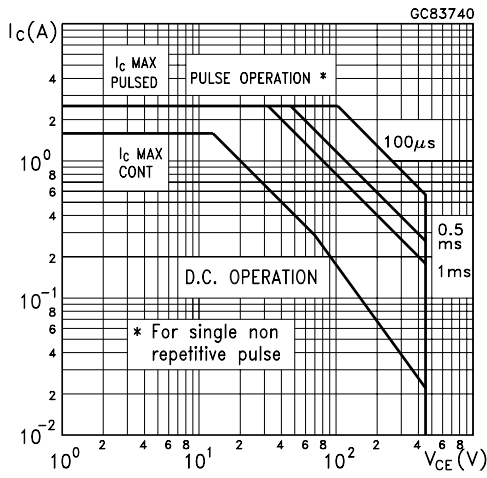

Derating Curve

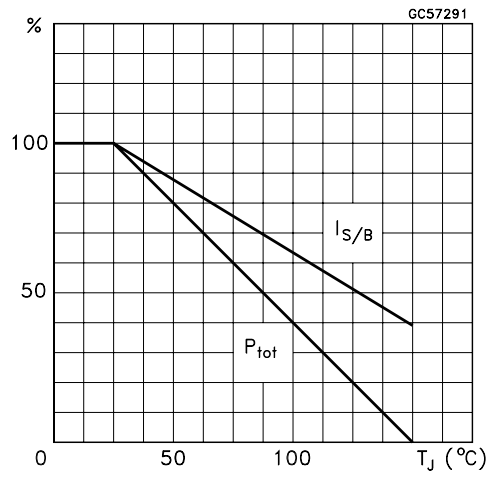

Reverse Biased SOA

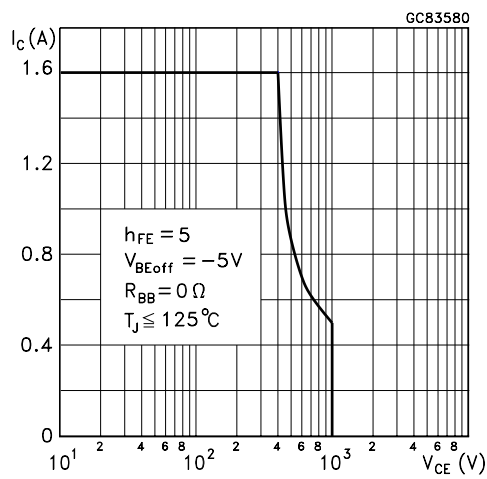

TO-251 (IPAK) MECHANICAL DATA

DIM.	mm			inch		
	MIN.	TYP.	MAX.	MIN.	TYP.	MAX.
A	2.20		2.40	0.087		0.094
A1	0.90		1.10	0.035		0.043
A3	0.70		1.30	0.028		0.051
B	0.64		0.90	0.025		0.035
B2	5.20		5.40	0.204		0.213
B3			0.85			0.033
B5		0.30			0.012	
B6			0.95			0.037
C	0.45		0.60	0.018		0.024
C2	0.48		0.60	0.019		0.024
D	6.00		6.20	0.237		0.244
E	6.40		6.60	0.252		0.260
G	4.40		4.60	0.173		0.181
H	15.90		16.30	0.626		0.642
L	9.00		9.40	0.354		0.370
L1	0.80		1.20	0.031		0.047
L2		0.80	1.00		0.031	0.039
V1		10°			10°	

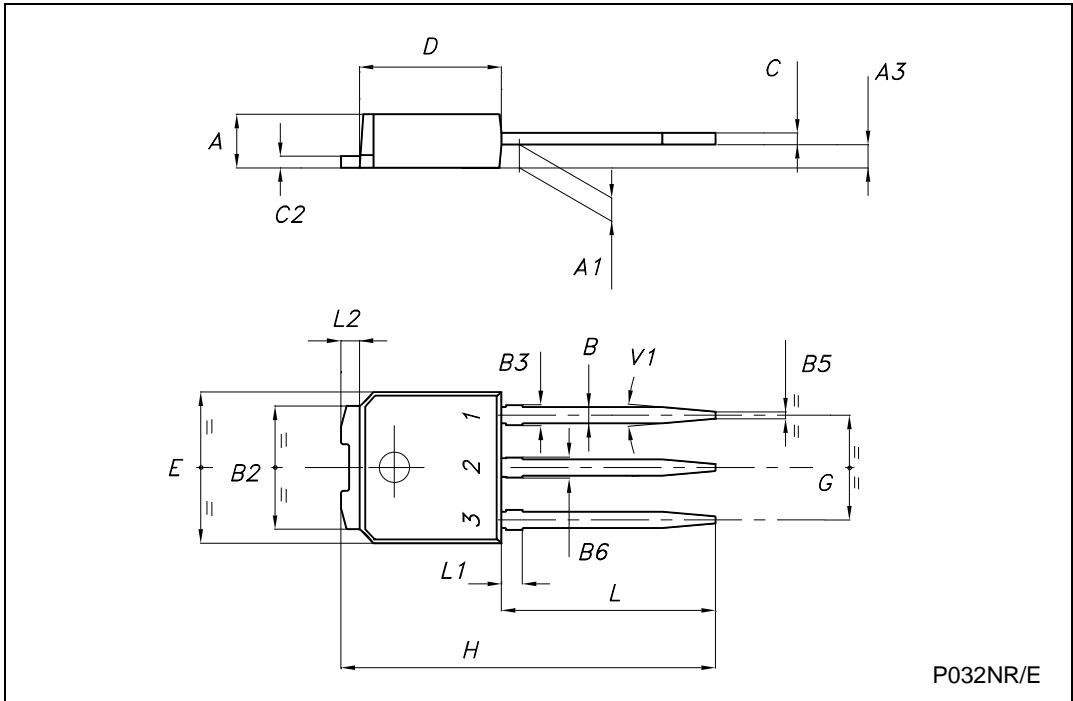

TO-252 (DPAK) MECHANICAL DATA

DIM.	mm			inch		
	MIN.	TYP.	MAX.	MIN.	TYP.	MAX.
A	2.20		2.40	0.087		0.094
A1	0.90		1.10	0.035		0.043
A2	0.03		0.23	0.001		0.009
B	0.64		0.90	0.025		0.035
B2	5.20		5.40	0.204		0.213
C	0.45		0.60	0.018		0.024
C2	0.48		0.60	0.019		0.024
D	6.00		6.20	0.236		0.244
E	6.40		6.60	0.252		0.260
G	4.40		4.60	0.173		0.181
H	9.35		10.10	0.368		0.398
L2		0.8			0.031	
L4	0.60		1.00	0.024		0.039
V2	0°		8°	0°		0°

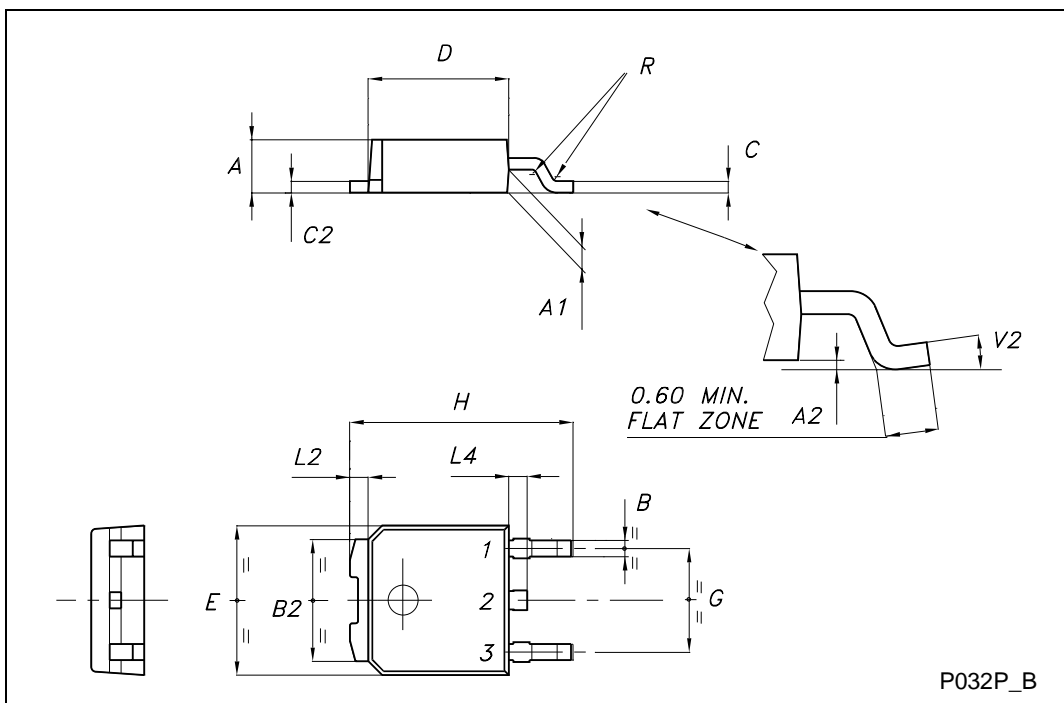

Information furnished is believed to be accurate and reliable. However, STMicroelectronics assumes no responsibility for the consequences of use of such information nor for any infringement of patents or other rights of third parties which may result from its use. No license is granted by implication or otherwise under any patent or patent rights of STMicroelectronics. Specification mentioned in this publication are subject to change without notice. This publication supersedes and replaces all information previously supplied. STMicroelectronics products are not authorized for use as critical components in life support devices or systems without express written approval of STMicroelectronics.

The ST logo is a trademark of STMicroelectronics

© 2001 STMicroelectronics – Printed in Italy – All Rights Reserved

STMicroelectronics GROUP OF COMPANIES

Australia - Brazil - China - Finland - France - Germany - Hong Kong - India - Italy - Japan - Malaysia - Malta - Morocco - Singapore - Spain - Sweden - Switzerland - United Kingdom - U.S.A.

<http://www.st.com>